

# こたえ

<b>1</b>	<b>1</b>	①1 ②2 ③3
	<b>2</b>	①いぬ ②さる ③ぞう
	<b>3</b>	
	<b>4</b>	
	<b>5</b>	
<b>2</b>	<b>1</b>	①4 ②5
	<b>2</b>	①かに ②かめ
	<b>3</b>	<b>4</b>
	<b>5</b>	しょうりやく
<b>3</b>	<b>1</b>	 2 3 1 4 5
	<b>2</b>	しょうりやく
	<b>3</b>	①みぎ ②ひだり ③ひだり ④ひだり
	<b>4</b>	1いち 2に 3さん 4し 5ご
<b>4</b>	<b>1</b>	<b>2</b> <b>4</b>
	<b>5</b>	<b>6</b> <b>8</b>
		しょうりやく
	<b>3</b>	
	<b>7</b>	

<b>5</b>	<b>1</b>	<b>2</b> <b>4</b>
	<b>5</b>	<b>6</b> <b>8</b>
		しょうりやく
	<b>3</b>	ぞう
	<b>7</b>	
<b>6</b>	<b>1</b>	<b>2</b>
		しょうりやく
	<b>3</b>	①みぎ②ひだり ③ひだり④みぎ ⑤ひだり⑥みぎ ⑦ひだり⑧みぎ ⑨ひだり
	<b>4</b>	①7 ②10 ③9
	<b>5</b>	6ろく 7しち 8はち 9く 10じゅう
<b>7</b>	<b>1</b>	①3②2③1
	<b>2</b>	<b>3</b> しょうりやく
<b>8</b>	<b>1</b>	①2②4③3④1
	<b>2</b>	①2②3③1④5 ⑤2
	<b>3</b>	①4②5③6④3 ⑤2
	<b>4</b>	①5②4③1④2 ⑤7
<b>9</b>	<b>1</b>	①4②3③8④6 ⑤2
	<b>2</b>	①3②5③3④4 ⑤1⑥1⑦4⑧3
	<b>3</b>	①1②2③7④4 ⑤5 ⑥4と6 ⑦3と7⑧2と8

<b>9</b>	<b>3</b>	⑨1と9 ⑩8 ⑪3⑫1⑬5
		(つづき)
<b>10</b>	<b>1</b>	①3②3③5 ④1⑤5⑥1 ⑦4⑧7⑨4 ⑩2⑪5⑫1
	<b>2</b>	①2②2③1 ④5⑤7⑥2 ⑦7⑧9
	<b>3</b>	1-9 4-6 3-7 2-8 5-5 9-1
<b>11</b>	<b>1</b>	① ②5だい ③
	<b>2</b>	① ② ③
	<b>3</b>	①さる ②うし ③いのしし ④ひつじ ⑤5
<b>12</b>	<b>1</b>	1, 2, 3
	<b>2</b>	①1+3=4 ②1+2=3 ③2+2=4 ④1+4=5 ⑤3+2=5 ⑥4+1=5
	<b>3</b>	①1+1=2 ②2+3=5 ③2+1=3 ④3+1=4
<b>13</b>	<b>1</b>	①1+3=4 4ほん ②1+4=5 5わ
	<b>2</b>	2+3=5 5にん
	<b>3</b>	①3②4③5④2 ⑤5⑥4⑦5⑧5

14	<p>1 <math>5 + 2 = 7</math> <u>7こ</u></p> <p>2 ①7②6③9④8 ⑤6⑥9</p> <p>3 5,3,あわせて <math>5 + 3 = 8</math> <u>8ひき</u></p>										
15	<p>1 <math>6 + 3 = 9</math> <u>9わ</u></p> <p>2 ①<math>5 + 4 = 9</math> <u>9さつ</u> ②<math>4 + 3 = 7</math> <u>7にん</u></p> <p>3 ①9②8③7 ④8⑤6⑥9 ⑦6⑧8⑨9</p>										
16	<p>1 <math>6 + 4 = 10</math> <u>10こ</u></p> <p>2 ①10②10③10 ④10⑤10</p> <p>3 ①<math>1 + 0 = 1</math> <u>1ひき</u> ②<math>2 + 0 = 2</math> <u>2ひき</u></p> <p>4 ①4②2③3 ④5⑤8⑥6 ⑦9⑧3⑨0</p>										
17	<p>1 ①3②5③8 ④8⑤10⑥10 ⑦6⑧7⑨10</p> <p>2 <table border="1" style="display: inline-table; vertical-align: middle;"> <tr><td>4 + 0</td><td>3 + 5</td></tr> <tr><td>8 + 1</td><td>2 + 4</td></tr> <tr><td>3 + 3</td><td>1 + 3</td></tr> <tr><td>6 + 2</td><td>6 + 3</td></tr> <tr><td>3 + 2</td><td>4 + 1</td></tr> </table></p> <p>3 ④しゅうりやく</p>	4 + 0	3 + 5	8 + 1	2 + 4	3 + 3	1 + 3	6 + 2	6 + 3	3 + 2	4 + 1
4 + 0	3 + 5										
8 + 1	2 + 4										
3 + 3	1 + 3										
6 + 2	6 + 3										
3 + 2	4 + 1										
18	<p>1 5, 2, 3</p> <p>2 3, 1, 2 <math>3 - 1 = 2</math></p> <p>3 ①2②1③1 ④1⑤4⑥2</p>										

19	<p>1 ㊦5 <math>8 - 3 = 5</math> <u>5まい</u></p> <p>2 ①4②2③4 ④4</p> <p>3 <math>9 - 4 = 5</math> <u>5だい</u></p> <p>4 ①3②1③5 ④3⑤5⑥2 ⑦2⑧8⑨4 ⑩1⑪2⑫1</p>
20	<p>1 ㊦6 <math>10 - 4 = 6</math> <u>6にん</u></p> <p>2 ①8②9③3 ④7⑤2⑥5 ⑦1⑧4⑨6</p> <p>3 ①<math>3 - 2 = 1</math> <u>1とう</u> ②<math>3 - 3 = 0</math> <u>0とう</u> ③<math>3 - 0 = 3</math> <u>3とう</u></p> <p>4 ①0②0③5 ④3⑤0⑥9</p>
21	<p>1 <math>7 - 5 = 2</math> ㊦2 <u>2つおおい</u></p> <p>2 <math>6 - 5 = 1</math> <u>1わおおい</u></p> <p>3 <math>7 - 3 = 4</math> <u>4ほん</u></p> <p>4 <math>5 - 3 = 2</math> <u>2ひき</u></p> <p>5 <math>9 - 4 = 5</math> <u>えんぴつが5つおおい</u></p>
22	<p>1 ①2②0③3 ④7⑤2⑥7 ⑦1⑧4⑨3</p> <p>2 <math>6 - 2 = 4</math> <u>4ひき</u></p> <p>3 <math>8 - 3 = 5</math> <u>ねこが5ひきおおい</u></p>

22 (つづき)	<p>4 <table border="1" style="display: inline-table; vertical-align: middle;"> <tr><td>5 - 2</td><td>9 - 3</td></tr> <tr><td>9 - 1</td><td>8 - 3</td></tr> <tr><td>9 - 5</td><td>7 - 4</td></tr> <tr><td>6 - 1</td><td>5 - 1</td></tr> <tr><td>8 - 2</td><td>8 - 0</td></tr> </table></p> <p>5 こたえが3は <math>5 - 2, 9 - 6, 4 - 1</math> <math>7 - 4, 6 - 3, 8 - 5</math> <math>3 - 0</math></p>	5 - 2	9 - 3	9 - 1	8 - 3	9 - 5	7 - 4	6 - 1	5 - 1	8 - 2	8 - 0													
5 - 2	9 - 3																							
9 - 1	8 - 3																							
9 - 5	7 - 4																							
6 - 1	5 - 1																							
8 - 2	8 - 0																							
23	<p>1 ①みぎ②ひだり ③みぎ④みぎ ⑤ひだり⑥ひだり</p> <p>2 ①3②2③5④10</p> <p>3 ① <del>✕</del> <del>✕</del> <del>○</del> <del>□</del> <del>○</del> <del>△</del> ② <del>▽</del> <del>◇</del> <del>▽</del> <del>□</del> <del>○</del> <del>△</del> ③ <del>▽</del> <del>◇</del> <del>▽</del> <del>□</del> <del>○</del> <del>△</del></p> <p>4 <math>4 + 5 = 9</math> <u>9ひき</u></p> <p>5 <math>10 - 3 = 7</math> <u>7まい</u></p> <p>6 ①7②4③10 ④10⑤3⑥5 ⑦4⑧9⑨7 ⑩7⑪2⑫10</p>																							
24	<p>1 <table border="1" style="display: inline-table; vertical-align: middle;"> <tr><td>○</td><td>い</td><td>と</td><td>㊦</td></tr> <tr><td>□</td><td>あ</td><td>と</td><td>㊦</td></tr> <tr><td>◇</td><td>う</td><td>と</td><td>㊦</td></tr> </table></p> <p>2 <table border="1" style="display: inline-table; vertical-align: middle;"> <tr><td>□</td><td>□</td><td>□</td><td>△</td></tr> <tr><td>4</td><td>1</td><td>2</td><td>2</td></tr> </table></p> <p>3 <table border="1" style="display: inline-table; vertical-align: middle;"> <tr><td>○</td><td>□</td><td>□</td></tr> </table> </p>	○	い	と	㊦	□	あ	と	㊦	◇	う	と	㊦	□	□	□	△	4	1	2	2	○	□	□
○	い	と	㊦																					
□	あ	と	㊦																					
◇	う	と	㊦																					
□	□	□	△																					
4	1	2	2																					
○	□	□																						
25	<p>1 ②3③13</p> <p>2 ②12</p> <p>3 ②14 (①しゅうりやく)</p>																							

26	1	①12 ②16 ③14
	2	9,12,16,18
	3	①12 ②15
	4	①13 ②10 ③5 ④9 ⑤10 ⑥10

27	1	㊦ 2    ㊧ 7 ㊨ 27    ㊩ <table border="1" style="display: inline-table; vertical-align: middle;"><tr><td>2</td><td>7</td></tr></table>	2	7
	2	7		
2	①36②53 ③20④25⑤33			

28	1	①35②32③50
	2	8,12,24,45,50 →
	3	①38②6 ③3,5④5
	4	ひよこ
	5	①27,30 ②30,36,38 ③46,40 ④15 ⑤35,50

29	1	①7じ ②8じ30ふん (8じはん) ③11じ45ふん ④12じ50ふん ⑤3じ30ふん (3じはん) ⑥6じ ⑦8じ33ふん (ふん)
----	---	---

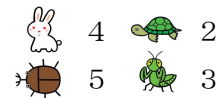
30	1	①2つ ②4つ
	2	①1つ ②3人 ③2人
	3	①かぶとむし ②かめ 

31	1	㊦10㊧12㊨10㊩12 9+3=12 12ひき
	2	①4②2③1④3
	3	①1,11②4,14 ③3,12④2,12 ⑤3,13⑥2,15
	4	①11②13③14 ④12⑤11⑥13
	5	8+4=12 12こ

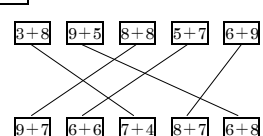
32	1	3+8=11 11こ ㊦ 2 ㊧ 11
	2	①3+9=12 ②4+7=11
	3	①11②13③12
	4	
	5	○は 5+9=14 9+5=14 7+5=12
	6	4+9=13 5+8=13 6+7=13 7+6=13 8+5=13 9+4=13

このうち4つ

33	1	6+5=11 11ぴき
	2	7+5=12 12さつ
	3	8+9=17 17にん
	4	4+7=11 11ぼん
	5	4+9=13 13にん
	6	①5②7③9 ④3⑤10⑥12 ⑦10⑧13⑨10 ⑩12⑪9⑫12
	7	①6②9 ③11④14

34	1	㊦ 3 12-9=3 3こ(つ)
	2	①3②8③5 ④7⑤6⑥3 ⑦5⑧9⑨8
	3	11-3=8 8まい
	4	①9②7③9 ④9⑤8⑥8 ⑦7⑧6⑨6

35	1	12-5=7 やきゅうボールが7こおい
	2	15-7=8 じてんしゃが8だいおい
	3	13-6=7 7こ
	4	16-7=9 9わ
	5	しょうりやく

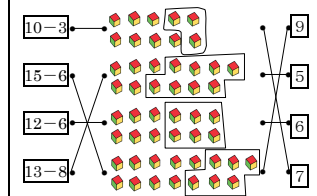
36	1	
	2	①8②4③9 ④8⑤7⑥8 ⑦9⑧9⑨4 ⑩5⑪6⑫7

36 (つ) (き)

③  $5 - 5 = 0$  0わ  
 ④  $8 - 0 = 8$  8まい  
 ⑤  $12 - 7 = 5$  5こ  
 ⑥ こたえが6は  
 $12 - 6$   $14 - 8$   
 $15 - 9$   $11 - 5$   
 $10 - 4$   $13 - 7$



37

①  $5 - 3 = 2$   
 ライオンが2とうおおい  
 ②  $6 + 10 = 16$  16こ  
 ③  $15 - 8 = 7$  7にん  
 ④  $8 - 5 = 3$  3びき  
 ⑤ ①  $8 + 4 = 12$   
 12わ  
 ②  $8 - 4 = 4$   
 ひよこが4わおおい

38

①  $15 - 7 = 8$  8こ  
 ②  $8 - 5 = 3$  3こ  
 ③  $4 + 5 + 8 = 17$   
 17にん  
 ④  $10 - 6 + 3 = 7$   
 7こ(つ)  
 ⑤ ①4②7③8  
 ④3  
 ⑥ ①2②6③7  
 ④8⑤7⑥3



39

①   
  
 ② 35こ  
 ③  $18, 26, 37, 45, 50$   
 ④ ①1じ  
 ②8じ15ふん

39 (つ) (き)

⑤ ①ぶどう  
 ②  $5 - 3 = 2$  2こ  
 ⑥ ①12②11③15  
 ④12⑤8⑥7  
 ⑦9⑧9⑨8  
 ⑩5⑩0

40

① イ  
 ② ウ  
 ③ イ  
 ④ ①ひだり②みぎ  
 ③うえ  
 ⑤ ①みぎ②ひだり  
 ⑥ ①   
 ② 

41

① ①35 ②52  
 ③63  
 ② ①73 ②90  
 ③70

42

① ①10  
 ② ①100  
 ②100  
 ③ ①ひだり②みぎ  
 ③ひだり④みぎ  
 ⑤みぎ

43

① 115  
 ② ①120  
 ②112  
 ③105  
 ③ ①35②97  
 ③48④90  
 ④ ①70②90③40  
 ④20

43 (つ) (き)

⑤  $182, 75, 59, 40, 36$   
 $104, 100, 99, 92, 73$

44

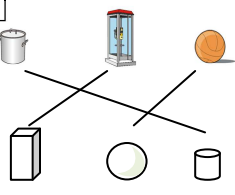
① ①8②6③9  
 ② ①9②13③15  
 ④4⑤3⑥9  
 ⑦9⑧9⑨0  
 ③ 25とう  
 ④   
 ⑤ ①① ②⑦  
 ⑥ 小さいかず 28  
 大きいかず 102  
 ⑦ ①102, 108, 117  
 ②30, 22, 14, 10